

## Detalii tehnice STP33A0400200S

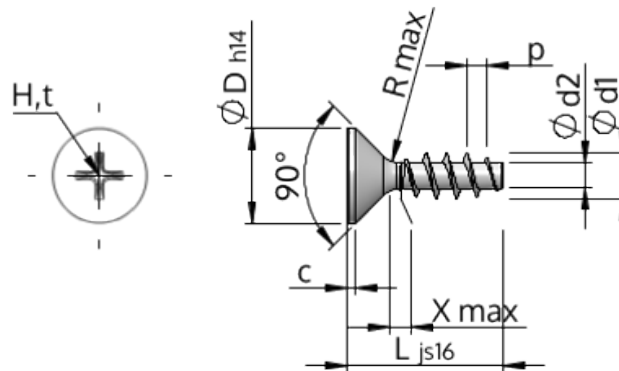

Numărul articolului		STP33A0400200S
Norma		KN1033
Material		oțel, călit
Exterior		zincat 5-7 $\mu\text{m}$ , repect, pasivat transparent/albastru
Diametrul exterior al filetului-Ø	<b>d1</b>	4.00 $^{+0.18}$ mm
Diametru șurub	<b>d2</b>	2.17 mm
Pasul filetului	<b>p</b>	1.79 mm
Lungimea	<b>L</b>	20.00 $\pm 0.65$ mm
Diametrul capului-Ø	<b>D</b>	8.40 $_{-0.36}$ mm
Cap cilindric	<b>C</b>	0.70 mm
Tija	<b>X</b>	2.00 mm
Radius	<b>R</b>	0.40 mm
Dimensiune Locaș Cruciform		H2
Adâncimea de penetrării	<b>t</b>	1.59 - 2.22 mm
Fir		STS
Greutate		1.432 kg / 1000 unități
Tariful vamal nr.		73 181 499