

Spec Sheet STP33A0400160S

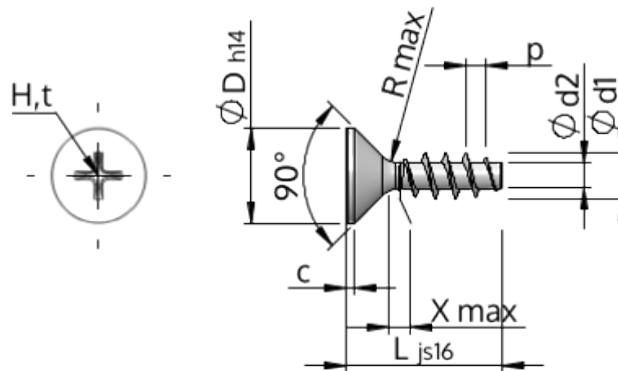

Item Number		STP33A0400160S
Standard		KN1033
Material		steel, hardened
Surface		zinc-plated 5-7 µm, baked, blue / transparent passivated
Thread Outside-Ø	<b>d1</b>	4.00 <sup>+0.18</sup> mm
Thread Core-Ø	<b>d2</b>	2.17 mm
Thread Pitch	<b>p</b>	1.79 mm
Length	<b>L</b>	16.00 ±0.55 mm
Head-Ø	<b>D</b>	8.40 <sub>-0.36</sub> mm
Cylindrical Head Height	<b>C</b>	0.70 mm
Thread Run-Out	<b>X</b>	2.00 mm
Radius	<b>R</b>	0.40 mm
Size Cross Recess		H2
Penetration Depth	<b>t</b>	1.59 - 2.22 mm
Thread		STS
Weight		1.239 kg / 1000 pieces
Customs Tariff No		73 181 499