

Spec Sheet STP33A0400140S

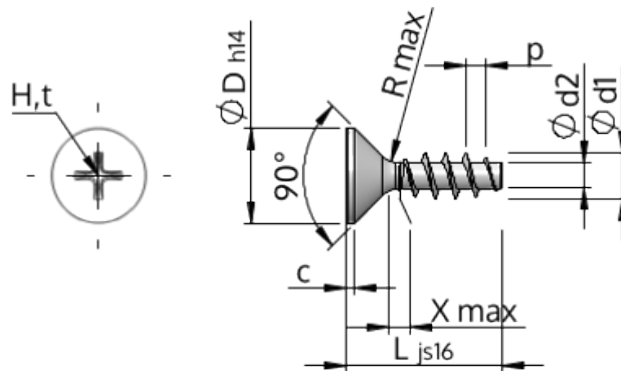

Item Number		STP33A0400140S
Standard		KN1033
Material		steel, hardened
Surface		zinc-plated 5-7 μm , baked, blue / transparent passivated
Thread Outside-Ø	d1	4.00 $^{+0.18}$ mm
Thread Core-Ø	d2	2.17 mm
Thread Pitch	p	1.79 mm
Length	L	14.00 ± 0.55 mm
Head-Ø	D	8.40 $_{-0.36}$ mm
Cylindrical Head Height	C	0.70 mm
Thread Run-Out	X	2.00 mm
Radius	R	0.40 mm
Size Cross Recess		H2
Penetration Depth	t	1.59 - 2.22 mm
Thread		STS
Weight		1.143 kg / 1000 pieces
Customs Tariff No		73 181 499