

Spec Sheet STP33A0400140E

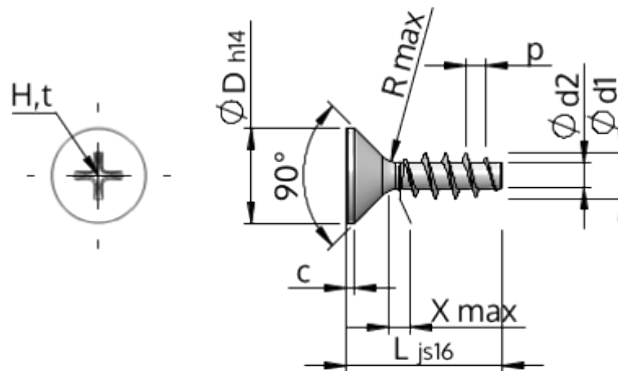

Item Number		STP33A0400140E
Standard		KN1033
Material		stainless-steel A2
Surface		bright, pickled and passivated
Thread Outside-Ø	d1	4.00 ^{+0.18} mm
Thread Core-Ø	d2	2.17 mm
Thread Pitch	p	1.79 mm
Length	L	14.00 ±0.55 mm
Head-Ø	D	8.40 _{-0.36} mm
Cylindrical Head Height	C	0.70 mm
Thread Run-Out	X	2.00 mm
Radius	R	0.40 mm
Size Cross Recess		H2
Penetration Depth	t	1.59 - 2.22 mm
Thread		STS
Weight		1.143 kg / 1000 pieces
Customs Tariff No		73 181 410