

Technische gegevens
STP33A0400120B

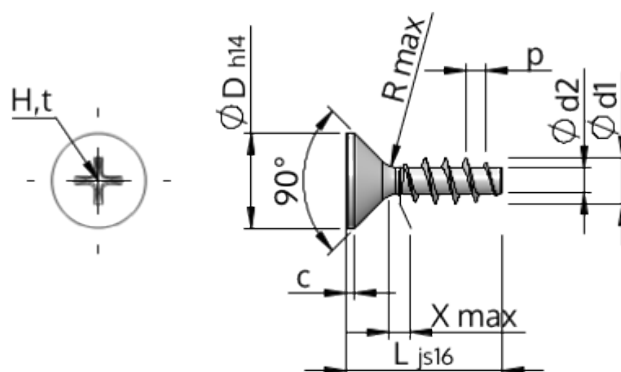

Produktnummer		STP33A0400120B
Norm		KN1033
Materiaal		veredeld staal
Oppervlak		ZnNi zwart-gepassiveerd, getempert, verzegeld
Schroefdraad buiten-Ø	d1	4.00 ^{+0.18} mm
Schroefdraad kern-Ø	d2	2.17 mm
Spoed	p	1.79 mm
Lengte	L	12.00 ±0.55 mm
Kop-Ø	D	8.40 _{-0.36} mm
Cylindrische kophoogte	C	0.70 mm
Draaduitloop	X	2.00 mm
Radius	R	0.40 mm
Kruis Maat		H2
Indringdiepte	t	1.59 - 2.22 mm
Draad		STS
Gewicht		1.046 kg / 1000 stuk
Douane tarief nummer		73 181 499