

**Technische gegevens**  
**STP33A0400100S**

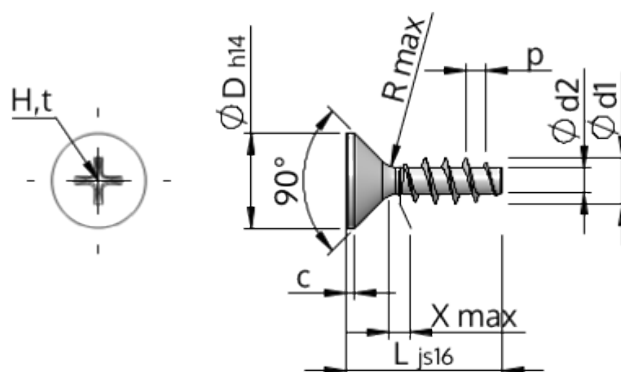

Produktnummer		STP33A0400100S
Norm		KN1033
Materiaal		veredeld staal
Oppervlak		verzinkt 5-7 µm, getempert, blauw / transparant gepassiveerd
Schroefdraad buiten-Ø	<b>d1</b>	4.00 <sup>+0.18</sup> mm
Schroefdraad kern-Ø	<b>d2</b>	2.17 mm
Spoed	<b>p</b>	1.79 mm
Lengte	<b>L</b>	10.00 ±0.45 mm
Kop-Ø	<b>D</b>	8.40 <sub>-0.36</sub> mm
Cylindrische kophoogte	<b>C</b>	0.70 mm
Draaduitloop	<b>X</b>	2.00 mm
Radius	<b>R</b>	0.40 mm
Kruis Maat		H2
Indringdiepte	<b>t</b>	1.59 - 2.22 mm
Draad		STS
Gewicht		0.950 kg / 1000 stuk
Douane tarief nummer		73 181 499