

Spec Sheet STP33A0400100S

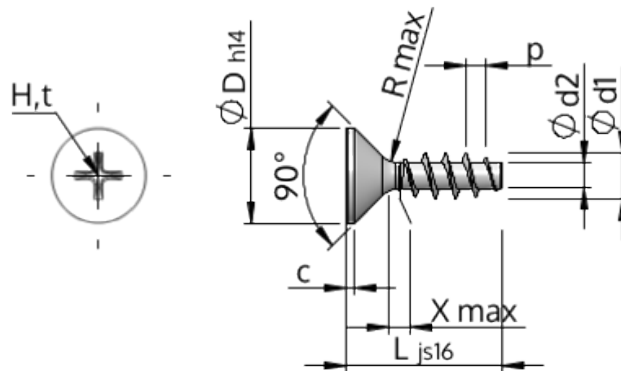

Item Number		STP33A0400100S
Standard		KN1033
Material		steel, hardened
Surface		zinc-plated 5-7 $\mu\text{m}$ , baked, blue / transparent passivated
Thread Outside-Ø	<b>d1</b>	4.00 $^{+0.18}$ mm
Thread Core-Ø	<b>d2</b>	2.17 mm
Thread Pitch	<b>p</b>	1.79 mm
Length	<b>L</b>	10.00 $\pm 0.45$ mm
Head-Ø	<b>D</b>	8.40 $_{-0.36}$ mm
Cylindrical Head Height	<b>C</b>	0.70 mm
Thread Run-Out	<b>X</b>	2.00 mm
Radius	<b>R</b>	0.40 mm
Size Cross Recess		H2
Penetration Depth	<b>t</b>	1.59 - 2.22 mm
Thread		STS
Weight		0.950 kg / 1000 pieces
Customs Tariff No		73 181 499