

Spec Sheet STP33A0350400E

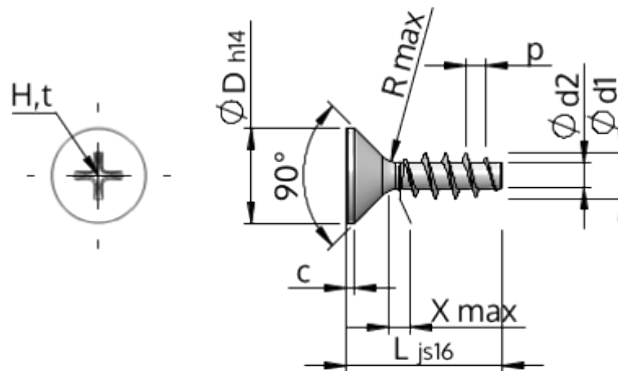

Item Number		STP33A0350400E
Standard		KN1033
Material		stainless-steel A2
Surface		bright, pickled and passivated
Thread Outside-Ø	d1	3.50 ^{+0.18} mm
Thread Core-Ø	d2	1.91 mm
Thread Pitch	p	1.57 mm
Length	L	40.00 ±0.80 mm
Head-Ø	D	7.30 _{-0.36} mm
Cylindrical Head Height	C	0.55 mm
Thread Run-Out	X	1.80 mm
Radius	R	0.35 mm
Size Cross Recess		H2
Penetration Depth	t	1.33 - 1.96 mm
Thread		STS
Weight		1.758 kg / 1000 pieces
Customs Tariff No		73 181 410