

Detalii tehnice STP33A0350160S

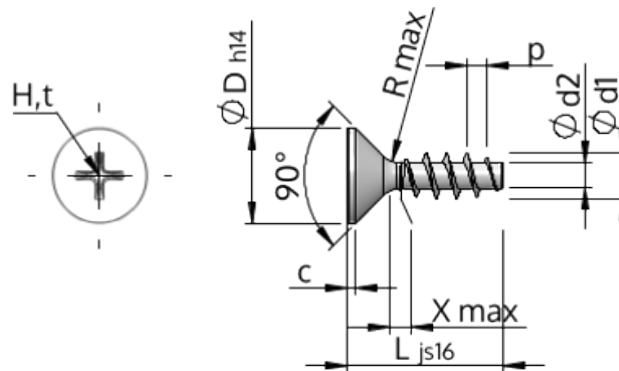

Numărul articolului		STP33A0350160S
Norma		KN1033
Material		oțel, călit
Exterior		zincat 5-7 μm , repect, pasivat transparent/albastru
Diametrul exterior al filetului-Ø	d1	3.50 $^{+0.18}$ mm
Diametru șurub	d2	1.91 mm
Pasul filetului	p	1.57 mm
Lungimea	L	16.00 ± 0.55 mm
Diametrul capului-Ø	D	7.30 $_{-0.36}$ mm
Cap cilindric	C	0.55 mm
Tija	X	1.80 mm
Radius	R	0.35 mm
Dimensiune Locaș Cruciform		H2
Adâncimea de penetrării	t	1.33 - 1.96 mm
Fir		STS
Greutate		0.866 kg / 1000 unități
Tariful vamal nr.		73 181 499