

Detalii tehnice STP33A0300300S

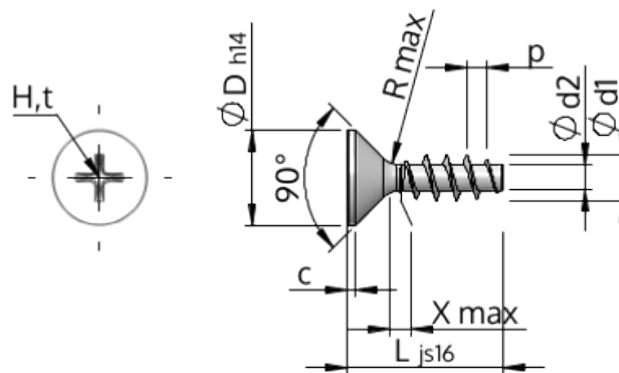

Numărul articolului		STP33A0300300S
Norma		KN1033
Material		oțel, călit
Exterior		zincat 5-7 μm , repect, pasivat transparent/albastru
Diametrul exterior al filetului-Ø	d1	3.00 $^{+0.14}$ mm
Diametru șurub	d2	1.66 mm
Pasul filetului	p	1.34 mm
Lungimea	L	30.00 ± 0.65 mm
Diametrul capului-Ø	D	5.50 $_{-0.30}$ mm
Cap cilindric	C	0.55 mm
Tija	X	1.50 mm
Radius	R	0.35 mm
Dimensiune Locaș Cruciform		H1
Adâncimea de penetrării	t	1.10 - 1.56 mm
Fir		STS
Greutate		0.959 kg / 1000 unități
Tarifal vamal nr.		73 181 499