

Spec Sheet STP33A0300300S

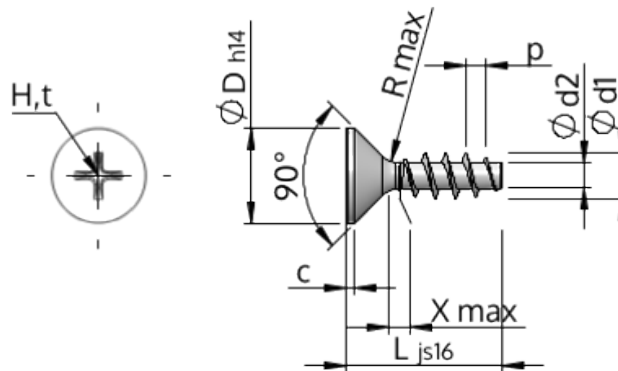

Item Number		STP33A0300300S
Standard		KN1033
Material		steel, hardened
Surface		zinc-plated 5-7 µm, baked, blue / transparent passivated
Thread Outside-Ø	<b>d1</b>	3.00 <sup>+0.14</sup> mm
Thread Core-Ø	<b>d2</b>	1.66 mm
Thread Pitch	<b>p</b>	1.34 mm
Length	<b>L</b>	30.00 ±0.65 mm
Head-Ø	<b>D</b>	5.50 <sub>-0.30</sub> mm
Cylindrical Head Height	<b>C</b>	0.55 mm
Thread Run-Out	<b>X</b>	1.50 mm
Radius	<b>R</b>	0.35 mm
Size Cross Recess		H1
Penetration Depth	<b>t</b>	1.10 - 1.56 mm
Thread		STS
Weight		0.959 kg / 1000 pieces
Customs Tariff No		73 181 499