

Spec Sheet STP33A0300250E

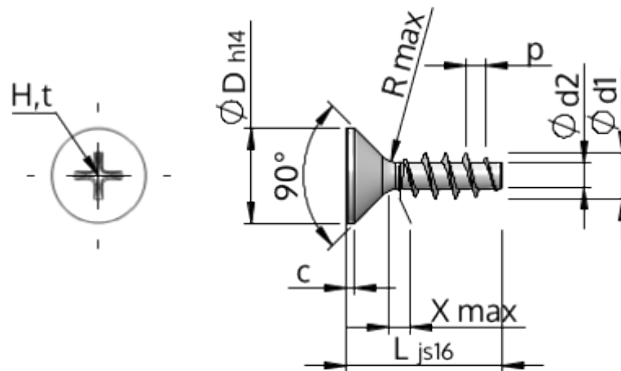

| | | |
|-------------------------|-----------|--------------------------------|
| Item Number | | STP33A0300250E |
| Standard | | KN1033 |
| Material | | stainless-steel A2 |
| Surface | | bright, pickled and passivated |
| Thread Outside-Ø | d1 | 3.00 ^{+0.14} mm |
| Thread Core-Ø | d2 | 1.66 mm |
| Thread Pitch | p | 1.34 mm |
| Length | L | 25.00 ±0.65 mm |
| Head-Ø | D | 5.50 _{-0.30} mm |
| Cylindrical Head Height | C | 0.55 mm |
| Thread Run-Out | X | 1.50 mm |
| Radius | R | 0.35 mm |
| Size Cross Recess | | H1 |
| Penetration Depth | t | 1.10 - 1.56 mm |
| Thread | | STS |
| Weight | | 0.816 kg / 1000 pieces |
| Customs Tariff No | | 73 181 410 |