

Detalii tehnice STP33A0300200S

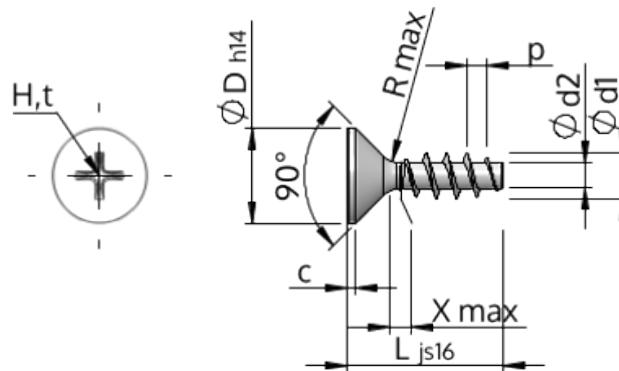

| | | |
|-----------------------------------|-----------|---|
| Numărul articolului | | STP33A0300200S |
| Norma | | KN1033 |
| Material | | oțel, călit |
| Exterior | | zincat 5-7 μm , repect, pasivat transparent/albastru |
| Diametrul exterior al filetului-Ø | d1 | 3.00 $^{+0.14}$ mm |
| Diametru șurub | d2 | 1.66 mm |
| Pasul filetului | p | 1.34 mm |
| Lungimea | L | 20.00 ± 0.65 mm |
| Diametrul capului-Ø | D | 5.50 $_{-0.30}$ mm |
| Cap cilindric | C | 0.55 mm |
| Tija | X | 1.50 mm |
| Radius | R | 0.35 mm |
| Dimensiune Locaș Cruciform | | H1 |
| Adâncimea de penetrării | t | 1.10 - 1.56 mm |
| Fir | | STS |
| Greutate | | 0.672 kg / 1000 unități |
| Tariful vamal nr. | | 73 181 499 |