

Spec Sheet STP33A0300140S

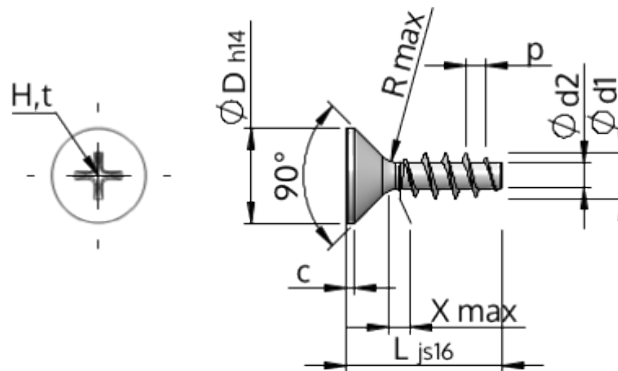

Item Number		STP33A0300140S
Standard		KN1033
Material		steel, hardened
Surface		zinc-plated 5-7 μm , baked, blue / transparent passivated
Thread Outside-Ø	d1	3.00 $^{+0.14}$ mm
Thread Core-Ø	d2	1.66 mm
Thread Pitch	p	1.34 mm
Length	L	14.00 ± 0.55 mm
Head-Ø	D	5.50 $_{-0.30}$ mm
Cylindrical Head Height	C	0.55 mm
Thread Run-Out	X	1.50 mm
Radius	R	0.35 mm
Size Cross Recess		H1
Penetration Depth	t	1.10 - 1.56 mm
Thread		STS
Weight		0.500 kg / 1000 pieces
Customs Tariff No		73 181 499