

Spec Sheet STP33A0250180S

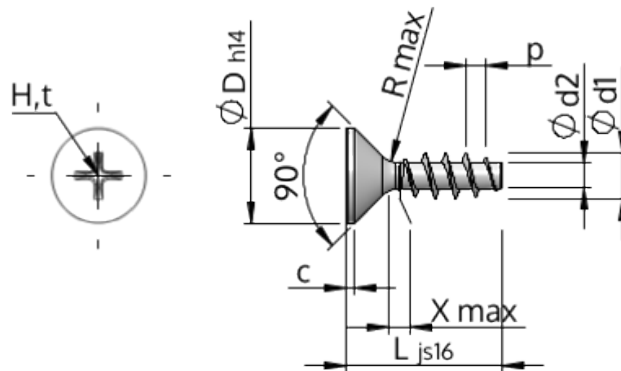

Item Number		STP33A0250180S
Standard		KN1033
Material		steel, hardened
Surface		zinc-plated 5-7 μm , baked, blue / transparent passivated
Thread Outside- Ø	d1	2.50 $^{+0.14}$ mm
Thread Core- Ø	d2	1.40 mm
Thread Pitch	p	1.12 mm
Length	L	18.00 ± 0.55 mm
Head- Ø	D	4.70 $_{-0.30}$ mm
Cylindrical Head Height	C	0.55 mm
Thread Run-Out	X	1.30 mm
Radius	R	0.30 mm
Size Cross Recess		H1
Penetration Depth	t	0.97 - 1.43 mm
Thread		STS
Weight		0.441 kg / 1000 pieces
Customs Tariff No		73 181 499