

Spec Sheet STP33A0250100E

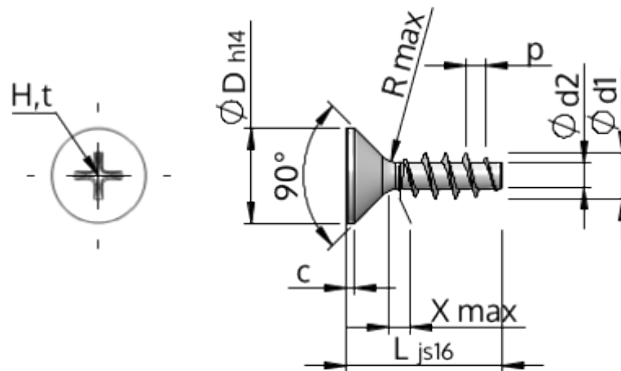

Item Number		STP33A0250100E
Standard		KN1033
Material		stainless-steel A2
Surface		bright, pickled and passivated
Thread Outside-Ø	d1	2.50 ^{+0.14} mm
Thread Core-Ø	d2	1.40 mm
Thread Pitch	p	1.12 mm
Length	L	10.00 ±0.45 mm
Head-Ø	D	4.70 _{-0.30} mm
Cylindrical Head Height	C	0.55 mm
Thread Run-Out	X	1.30 mm
Radius	R	0.30 mm
Size Cross Recess		H1
Penetration Depth	t	0.97 - 1.43 mm
Thread		STS
Weight		0.277 kg / 1000 pieces
Customs Tariff No		73 181 410