

Spec Sheet STP33A0220220E

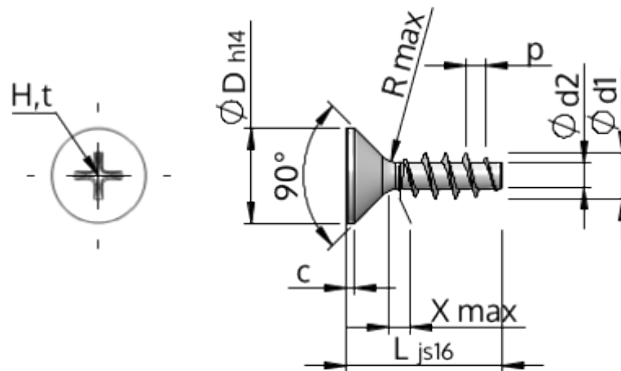

Item Number		STP33A0220220E
Standard		KN1033
Material		stainless-steel A2
Surface		bright, pickled and passivated
Thread Outside-Ø	<b>d1</b>	2.20 <sup>+0.14</sup> mm
Thread Core-Ø	<b>d2</b>	1.25 mm
Thread Pitch	<b>p</b>	0.98 mm
Length	<b>L</b>	22.00 ±0.65 mm
Head-Ø	<b>D</b>	3.80 <sub>-0.30</sub> mm
Cylindrical Head Height	<b>C</b>	0.35 mm
Thread Run-Out	<b>X</b>	1.10 mm
Radius	<b>R</b>	0.25 mm
Size Cross Recess		H1
Penetration Depth	<b>t</b>	0.95 - 1.25 mm
Thread		STS
Weight		0.380 kg / 1000 pieces
Customs Tariff No		73 181 410