

Detalii tehnice STP33A0220080S

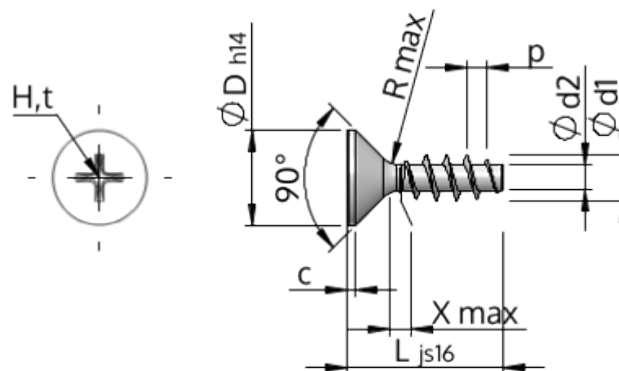

Numărul articolului		STP33A0220080S
Norma		KN1033
Material		oțel, călit
Exterior		zincat 5-7 μ m, repect, pasivat transparent/albastru
Diametrul exterior al filetului-Ø	d1	2.20 $^{+0.14}$ mm
Diametru șurub	d2	1.25 mm
Pasul filetului	p	0.98 mm
Lungimea	L	8.00 ± 0.45 mm
Diametrul capului-Ø	D	3.80 $_{-0.30}$ mm
Cap cilindric	C	0.35 mm
Tija	X	1.10 mm
Radius	R	0.25 mm
Dimensiune Locaș Cruciform		H1
Adâncimea de penetrării	t	0.95 - 1.25 mm
Fir		STS
Greutate		0.158 kg / 1000 unități
Tariful vamal nr.		73 181 499