

Spec Sheet STP33A0220045E

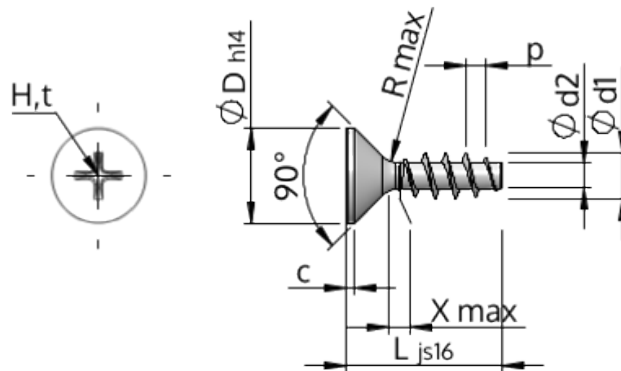

Item Number		STP33A0220045E
Standard		KN1033
Material		stainless-steel A2
Surface		bright, pickled and passivated
Thread Outside-Ø	d1	2.20 ^{+0.14} mm
Thread Core-Ø	d2	1.25 mm
Thread Pitch	p	0.98 mm
Length	L	4.50 ±0.38 mm
Head-Ø	D	3.80 _{-0.30} mm
Cylindrical Head Height	C	0.35 mm
Thread Run-Out	X	1.10 mm
Radius	R	0.25 mm
Size Cross Recess		H1
Penetration Depth	t	0.95 - 1.25 mm
Thread		STS
Weight		0.102 kg / 1000 pieces
Customs Tariff No		73 181 410