

## Detalii tehnice STP33A0200180S

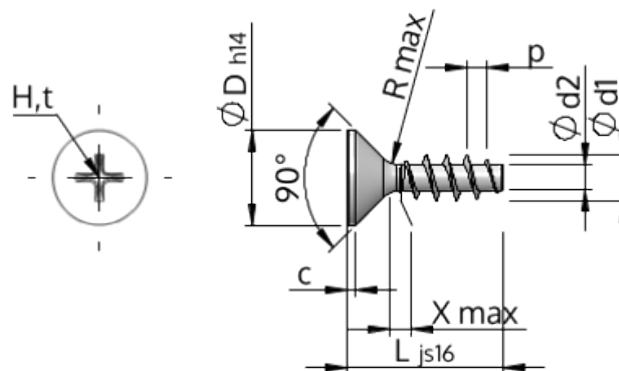

Numărul articolului		STP33A0200180S
Norma		KN1033
Material		oțel, călit
Exterior		zincat 5-7 $\mu\text{m}$ , repect, pasivat transparent/albastru
Diametrul exterior al filetului-Ø	<b>d1</b>	2.00 $^{+0.14}$ mm
Diametru șurub	<b>d2</b>	1.15 mm
Pasul filetului	<b>p</b>	0.89 mm
Lungimea	<b>L</b>	18.00 $\pm 0.55$ mm
Diametrul capului-Ø	<b>D</b>	3.80 $_{-0.30}$ mm
Cap cilindric	<b>C</b>	0.35 mm
Tija	<b>X</b>	1.00 mm
Radius	<b>R</b>	0.25 mm
Dimensiune Locaș Cruciform		H1
Adâncimea de penetrării	<b>t</b>	0.95 - 1.25 mm
Fir		STS
Greutate		0.308 kg / 1000 unități
Tariful vamal nr.		73 181 499