

Spec Sheet STP33A0200180S

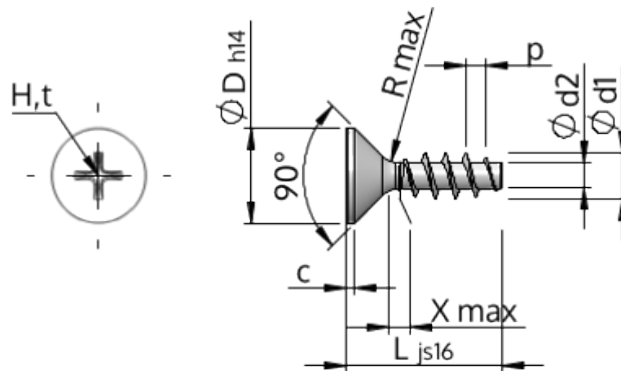

Item Number		STP33A0200180S
Standard		KN1033
Material		steel, hardened
Surface		zinc-plated 5-7 μm , baked, blue / transparent passivated
Thread Outside-Ø	d1	2.00 $^{+0.14}$ mm
Thread Core-Ø	d2	1.15 mm
Thread Pitch	p	0.89 mm
Length	L	18.00 ± 0.55 mm
Head-Ø	D	3.80 $_{-0.30}$ mm
Cylindrical Head Height	C	0.35 mm
Thread Run-Out	X	1.00 mm
Radius	R	0.25 mm
Size Cross Recess		H1
Penetration Depth	t	0.95 - 1.25 mm
Thread		STS
Weight		0.308 kg / 1000 pieces
Customs Tariff No		73 181 499