

Spec Sheet STP33A0200100E

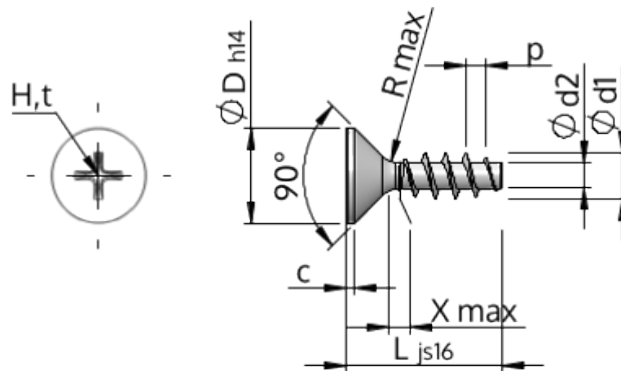

Item Number		STP33A0200100E
Standard		KN1033
Material		stainless-steel A2
Surface		bright, pickled and passivated
Thread Outside-Ø	d1	2.00 ^{+0.14} mm
Thread Core-Ø	d2	1.15 mm
Thread Pitch	p	0.89 mm
Length	L	10.00 ±0.45 mm
Head-Ø	D	3.80 _{-0.30} mm
Cylindrical Head Height	C	0.35 mm
Thread Run-Out	X	1.00 mm
Radius	R	0.25 mm
Size Cross Recess		H1
Penetration Depth	t	0.95 - 1.25 mm
Thread		STS
Weight		0.193 kg / 1000 pieces
Customs Tariff No		73 181 410