

Spec Sheet STP320600320B

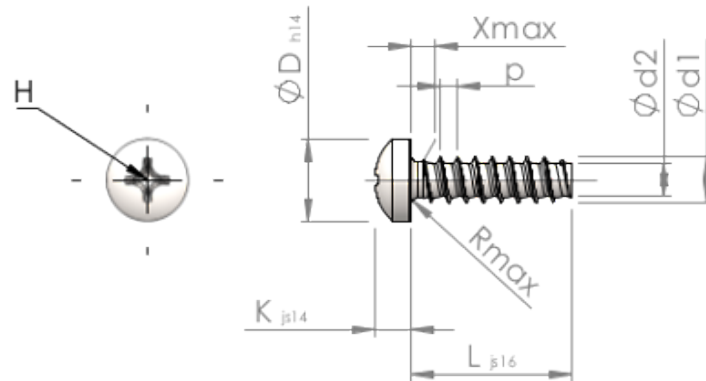

Item Number		STP320600320B
Standard		KN6032
Material		steel, hardened
Surface		Zinc-Nickel-plated min. 5µm, passivated black/ Cr-VI-free, baked, sealed
Thread Outside-Ø	<b>d1</b>	6.00 <sup>+0.15</sup> mm
Thread Core-Ø	<b>d2</b>	4.26 mm
Thread Pitch	<b>p</b>	2.14 mm
Length	<b>L</b>	32.00 ±0.80 mm
Head-Ø	<b>D</b>	10.50 <sub>-0.43</sub> mm
Head Height	<b>K</b>	4.200 ±0.150 mm
Thread Run-Out	<b>X</b>	3.00 mm
Radius	<b>R</b>	0.80 mm
Size Cross Recess		H3
Penetration Depth	<b>t</b>	2.44 - 3.10 mm
Thread		STS-plus
Weight		6.224 kg / 1000 pieces
Customs Tariff No		73 181 499