

Technische gegevens
STP320600220E

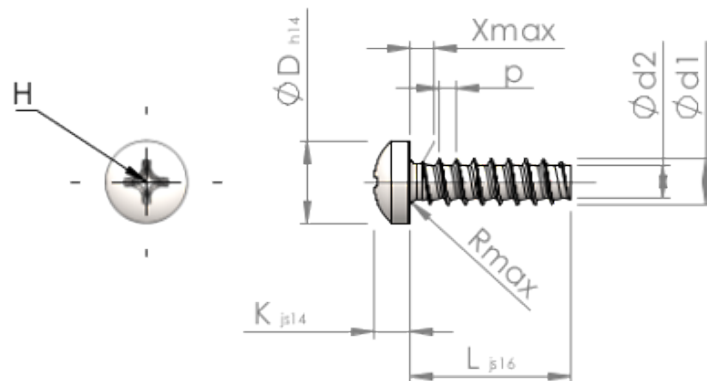

Produktnummer		STP320600220E
Norm		KN6032
Materiaal		roestvrij staal A2
Oppervlak		blank, geetst en gepassiveerd
Schroefdraad buiten-Ø	d1	6.00 ^{+0.15} mm
Schroefdraad kern-Ø	d2	4.26 mm
Spoed	p	2.14 mm
Lengte	L	22.00 ±0.65 mm
Kop-Ø	D	10.50 _{-0.43} mm
Kop hoogte	K	4.200 ±0.150 mm
Draaduitloop	X	3.00 mm
Radius	R	0.80 mm
Kruis Maat		H3
Indringdiepte	t	2.44 - 3.10 mm
Draad		STS-plus
Gewicht		4.868 kg / 1000 stuk
Douane tarief nummer		73 181 410