

**Technische gegevens**  
**STP320600200E**

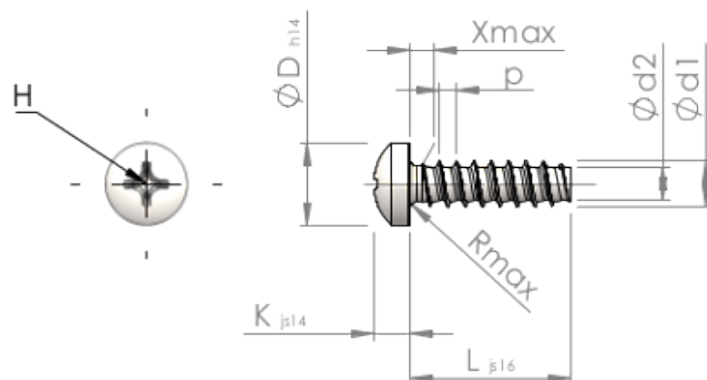

Produktnummer		STP320600200E
Norm		KN6032
Materiaal		roestvrij staal A2
Oppervlak		blank, geetst en gepassiveerd
Schroefdraad buiten-Ø	<b>d1</b>	6.00 <sup>+0.15</sup> mm
Schroefdraad kern-Ø	<b>d2</b>	4.26 mm
Spoed	<b>p</b>	2.14 mm
Lengte	<b>L</b>	20.00 ±0.65 mm
Kop-Ø	<b>D</b>	10.50 <sub>-0.43</sub> mm
Kop hoogte	<b>K</b>	4.200 ±0.150 mm
Draaduitloop	<b>X</b>	3.00 mm
Radius	<b>R</b>	0.80 mm
Kruis Maat		H3
Indringdiepte	<b>t</b>	2.44 - 3.10 mm
Draad		STS-plus
Gewicht		4.596 kg / 1000 stuk
Douane tarief nummer		73 181 410