

Spec Sheet STP320500400S

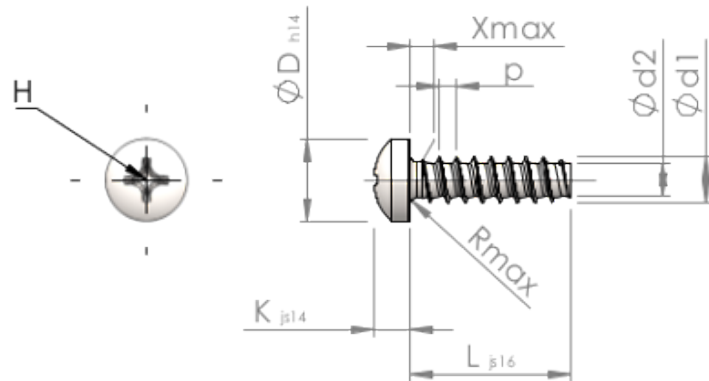

Item Number		STP320500400S
Standard		KN6032
Material		steel, hardened
Surface		zinc-plated 5-7 µm, baked, blue / transparent passivated
Thread Outside-Ø	d1	5.00 ^{+0.15} mm
Thread Core-Ø	d2	3.53 mm
Thread Pitch	p	1.80 mm
Length	L	40.00 ±0.80 mm
Head-Ø	D	8.80 _{-0.36} mm
Head Height	K	3.500 ±0.150 mm
Thread Run-Out	X	2.50 mm
Radius	R	0.70 mm
Size Cross Recess		H2
Penetration Depth	t	2.12 - 2.75 mm
Thread		STS-plus
Weight		4.898 kg / 1000 pieces
Customs Tariff No		73 181 499