

Technische gegevens
STP320500250S

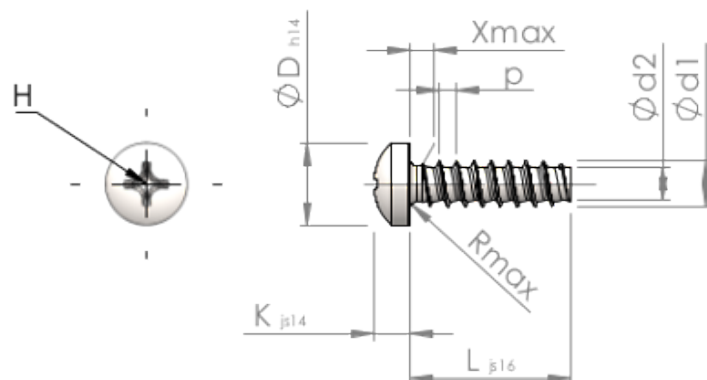

Produktnummer		STP320500250S
Norm		KN6032
Materiaal		veredeld staal
Oppervlak		verzinkt 5-7 µm, getempert, blauw / transparant gepassiveerd
Schroefdraad buiten-Ø	d1	5.00 ^{+0.15} mm
Schroefdraad kern-Ø	d2	3.53 mm
Spoed	p	1.80 mm
Lengte	L	25.00 ±0.65 mm
Kop-Ø	D	8.80 _{-0.36} mm
Kop hoogte	K	3.500 ±0.150 mm
Draaduitloop	X	2.50 mm
Radius	R	0.70 mm
Kruis Maat		H2
Indringdiepte	t	2.12 - 2.75 mm
Draad		STS-plus
Gewicht		3.479 kg / 1000 stuk
Douane tarief nummer		73 181 499