

Spec Sheet STP320450500B

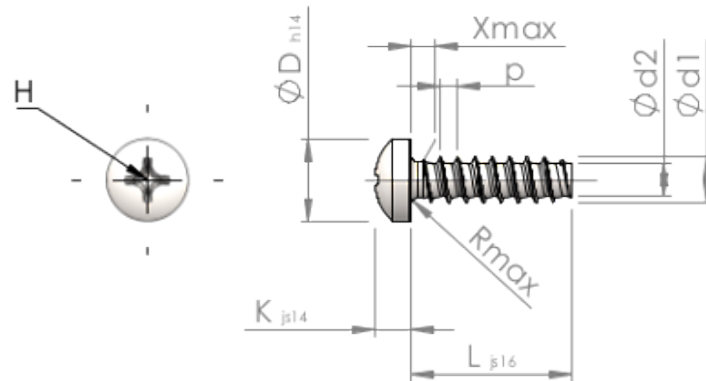

Item Number		STP320450500B
Standard		KN6032
Material		steel, hardened
Surface		Zinc-Nickel-plated min. 5µm, passivated black/ Cr-VI-free, baked, sealed
Thread Outside-Ø	<b>d1</b>	4.50 <sup>+0.10</sup> mm
Thread Core-Ø	<b>d2</b>	3.17 mm
Thread Pitch	<b>p</b>	1.63 mm
Length	<b>L</b>	50.00 ±0.80 mm
Head-Ø	<b>D</b>	7.50 <sub>-0.36</sub> mm
Head Height	<b>K</b>	3.200 ±0.150 mm
Thread Run-Out	<b>X</b>	2.30 mm
Radius	<b>R</b>	0.60 mm
Size Cross Recess		H2
Penetration Depth	<b>t</b>	1.51 - 2.14 mm
Thread		STS-plus
Weight		4.572 kg / 1000 pieces
Customs Tariff No		73 181 499