

**Technische gegevens**  
**STP320450350S**

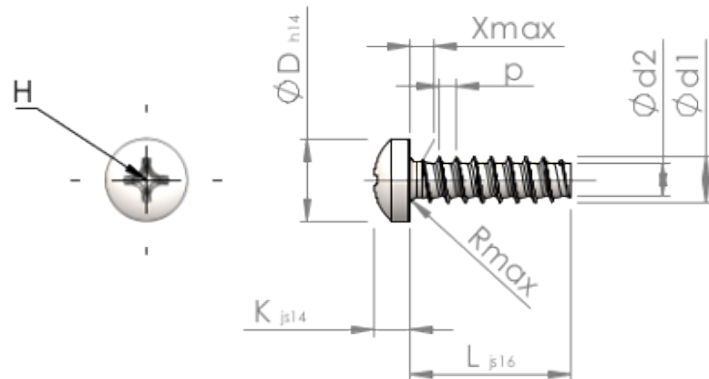

Produktnummer		STP320450350S
Norm		KN6032
Materiaal		veredeld staal
Oppervlak		verzinkt 5-7 µm, getempert, blauw / transparant gepassiveerd
Schroefdraad buiten-Ø	<b>d1</b>	4.50 <sup>+0.10</sup> mm
Schroefdraad kern-Ø	<b>d2</b>	3.17 mm
Spoed	<b>p</b>	1.63 mm
Lengte	<b>L</b>	35.00 ±0.80 mm
Kop-Ø	<b>D</b>	7.50 <sub>-0.36</sub> mm
Kop hoogte	<b>K</b>	3.200 ±0.150 mm
Draaduitloop	<b>X</b>	2.30 mm
Radius	<b>R</b>	0.60 mm
Kruis Maat		H2
Indringdiepte	<b>t</b>	1.51 - 2.14 mm
Draad		STS-plus
Gewicht		3.418 kg / 1000 stuk
Douane tarief nummer		73 181 499