

Spec Sheet STP320450180S

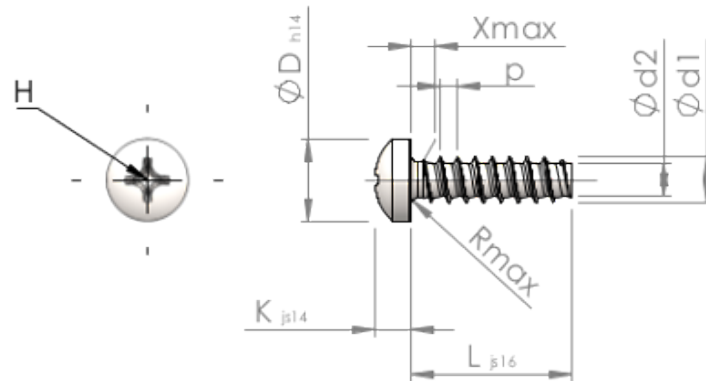

Item Number		STP320450180S
Standard		KN6032
Material		steel, hardened
Surface		zinc-plated 5-7 µm, baked, blue / transparent passivated
Thread Outside-Ø	d1	4.50 ^{+0.10} mm
Thread Core-Ø	d2	3.17 mm
Thread Pitch	p	1.63 mm
Length	L	18.00 ±0.55 mm
Head-Ø	D	7.50 _{-0.36} mm
Head Height	K	3.200 ±0.150 mm
Thread Run-Out	X	2.30 mm
Radius	R	0.60 mm
Size Cross Recess		H2
Penetration Depth	t	1.51 - 2.14 mm
Thread		STS-plus
Weight		2.111 kg / 1000 pieces
Customs Tariff No		73 181 499