

Technische gegevens
STP320400170C

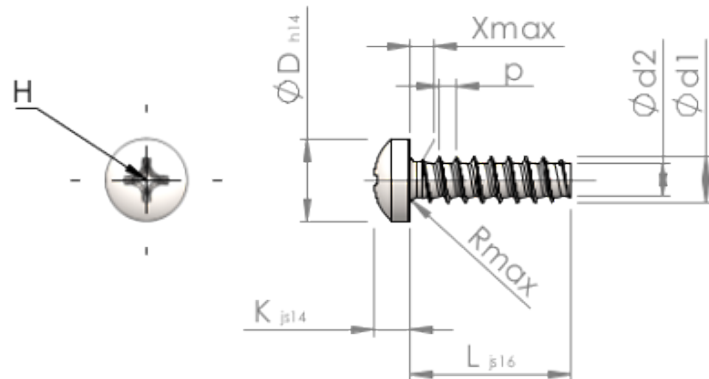

Produktnummer		STP320400170C
Norm		KN6032
Materiaal		roestvrij staal A4
Oppervlak		blank, geetst en gepassiveerd
Schroefdraad buiten-Ø	d1	4.00 ^{+0.10} mm
Schroefdraad kern-Ø	d2	2.81 mm
Spoed	p	1.46 mm
Lengte	L	17.00 ±0.55 mm
Kop-Ø	D	7.00 _{-0.36} mm
Kop hoogte	K	3.100 ±0.150 mm
Draaduitloop	X	2.00 mm
Radius	R	0.60 mm
Kruis Maat		H2
Indringdiepte	t	1.51 - 2.14 mm
Draad		STS-plus
Gewicht		1.644 kg / 1000 stuk
Douane tarief nummer		73 181 410