

Spec Sheet STP320400150S

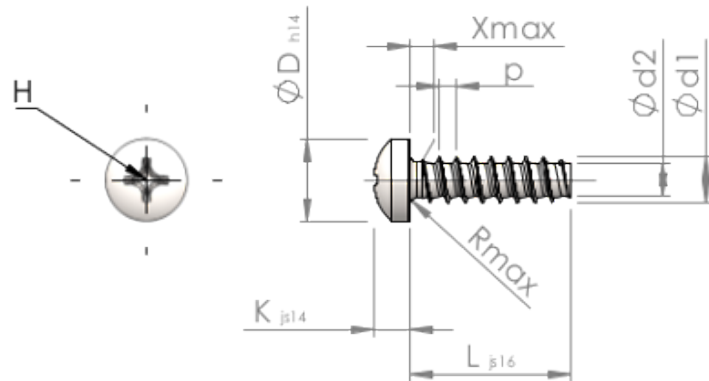

Item Number		STP320400150S
Standard		KN6032
Material		steel, hardened
Surface		zinc-plated 5-7 µm, baked, blue / transparent passivated
Thread Outside-Ø	d1	4.00 ^{+0.10} mm
Thread Core-Ø	d2	2.81 mm
Thread Pitch	p	1.46 mm
Length	L	15.00 ±0.55 mm
Head-Ø	D	7.00 _{-0.36} mm
Head Height	K	3.100 ±0.150 mm
Thread Run-Out	X	2.00 mm
Radius	R	0.60 mm
Size Cross Recess		H2
Penetration Depth	t	1.51 - 2.14 mm
Thread		STS-plus
Weight		1.523 kg / 1000 pieces
Customs Tariff No		73 181 499