

Spec Sheet STP320350120S

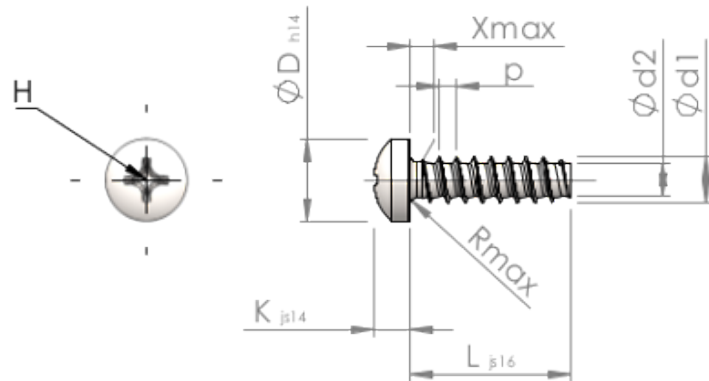

Item Number		STP320350120S
Standard		KN6032
Material		steel, hardened
Surface		zinc-plated 5-7 µm, baked, blue / transparent passivated
Thread Outside-Ø	d1	3.50 ^{+0.10} mm
Thread Core-Ø	d2	2.45 mm
Thread Pitch	p	1.29 mm
Length	L	12.00 ±0.55 mm
Head-Ø	D	6.10 _{-0.36} mm
Head Height	K	2.700 ±0.125 mm
Thread Run-Out	X	1.80 mm
Radius	R	0.50 mm
Size Cross Recess		H2
Penetration Depth	t	1.23 - 1.86 mm
Thread		STS-plus
Weight		0.983 kg / 1000 pieces
Customs Tariff No		73 181 499