

Technische gegevens
STP320350100C

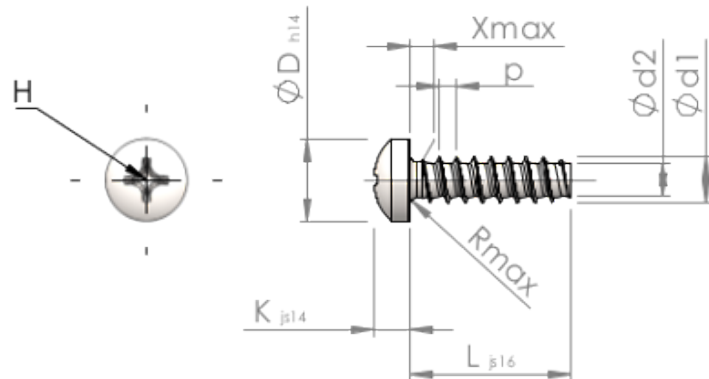

Produktnummer		STP320350100C
Norm		KN6032
Materiaal		roestvrij staal A4
Oppervlak		blank, geetst en gepassiveerd
Schroefdraad buiten-Ø	d1	3.50 ^{+0.10} mm
Schroefdraad kern-Ø	d2	2.45 mm
Spoed	p	1.29 mm
Lengte	L	10.00 ±0.45 mm
Kop-Ø	D	6.10 _{-0.36} mm
Kop hoogte	K	2.700 ±0.125 mm
Draaduitloop	X	1.80 mm
Radius	R	0.50 mm
Kruis Maat		H2
Indringdiepte	t	1.23 - 1.86 mm
Draad		STS-plus
Gewicht		0.889 kg / 1000 stuk
Douane tarief nummer		73 181 410