

Spec Sheet STP320300050B

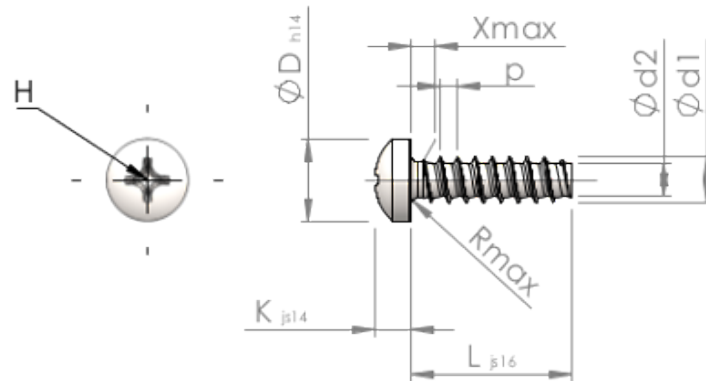

Item Number		STP320300050B
Standard		KN6032
Material		steel, hardened
Surface		Zinc-Nickel-plated min. 5µm, passivated black/ Cr-VI-free, baked, sealed
Thread Outside-Ø	d1	3.00 ^{+0.10} mm
Thread Core-Ø	d2	2.09 mm
Thread Pitch	p	1.12 mm
Length	L	5.00 ±0.38 mm
Head-Ø	D	5.30 _{-0.30} mm
Head Height	K	2.300 ±0.125 mm
Thread Run-Out	X	1.50 mm
Radius	R	0.50 mm
Size Cross Recess		H1
Penetration Depth	t	1.19 - 1.65 mm
Thread		STS-plus
Weight		0.445 kg / 1000 pieces
Customs Tariff No		73 181 499