

Spec Sheet STP320250200S

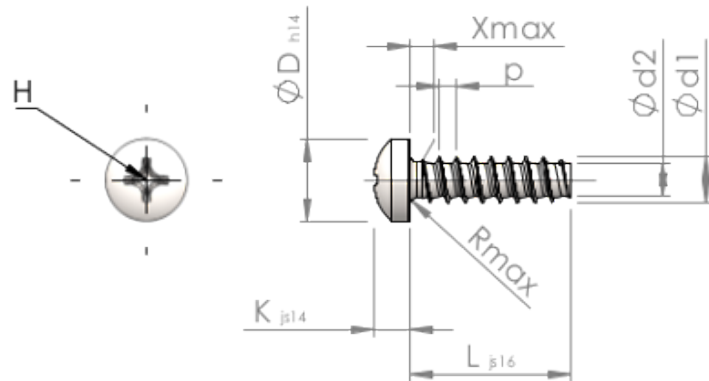

Item Number		STP320250200S
Standard		KN6032
Material		steel, hardened
Surface		zinc-plated 5-7 µm, baked, blue / transparent passivated
Thread Outside-Ø	d1	2.50 ^{+0.10} mm
Thread Core-Ø	d2	1.72 mm
Thread Pitch	p	0.95 mm
Length	L	20.00 ±0.65 mm
Head-Ø	D	4.40 _{-0.30} mm
Head Height	K	1.900 ±0.125 mm
Thread Run-Out	X	1.30 mm
Radius	R	0.40 mm
Size Cross Recess		H1
Penetration Depth	t	0.92 - 1.38 mm
Thread		STS-plus
Weight		0.626 kg / 1000 pieces
Customs Tariff No		73 181 499