

Spec Sheet STP320250170E

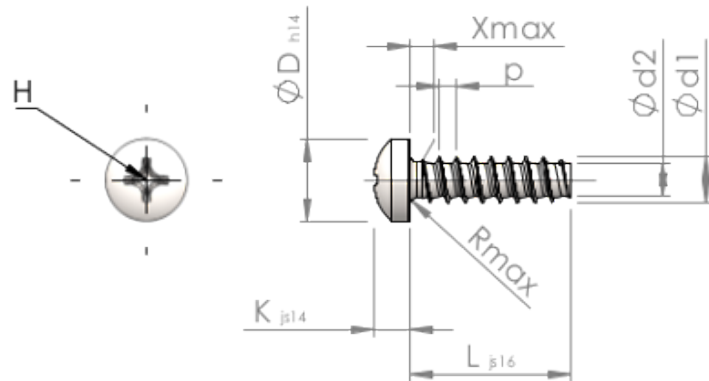

Item Number		STP320250170E
Standard		KN6032
Material		stainless-steel A2
Surface		bright, pickled and passivated
Thread Outside-Ø	<b>d1</b>	2.50 <sup>+0.10</sup> mm
Thread Core-Ø	<b>d2</b>	1.72 mm
Thread Pitch	<b>p</b>	0.95 mm
Length	<b>L</b>	17.00 ±0.55 mm
Head-Ø	<b>D</b>	4.40 <sub>-0.30</sub> mm
Head Height	<b>K</b>	1.900 ±0.125 mm
Thread Run-Out	<b>X</b>	1.30 mm
Radius	<b>R</b>	0.40 mm
Size Cross Recess		H1
Penetration Depth	<b>t</b>	0.92 - 1.38 mm
Thread		STS-plus
Weight		0.554 kg / 1000 pieces
Customs Tariff No		73 181 410