

Technische gegevens
STP320250100S

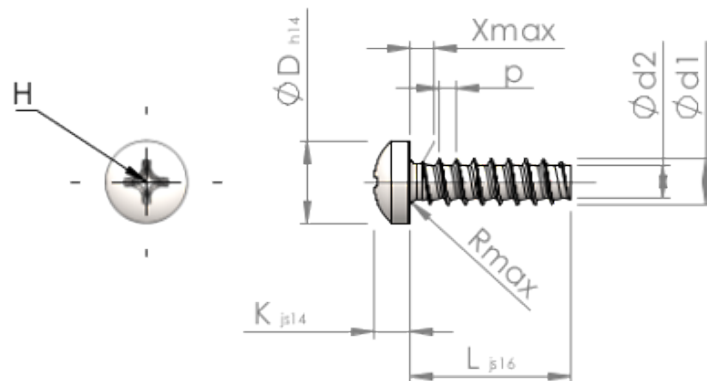

Produktnummer		STP320250100S
Norm		KN6032
Materiaal		veredeld staal
Oppervlak		verzinkt 5-7 µm, getempert, blauw / transparant gepassiveerd
Schroefdraad buiten-Ø	d1	2.50 ^{+0.10} mm
Schroefdraad kern-Ø	d2	1.72 mm
Spoed	p	0.95 mm
Lengte	L	10.00 ±0.45 mm
Kop-Ø	D	4.40 _{-0.30} mm
Kop hoogte	K	1.900 ±0.125 mm
Draaduitloop	X	1.30 mm
Radius	R	0.40 mm
Kruis Maat		H1
Indringdiepte	t	0.92 - 1.38 mm
Draad		STS-plus
Gewicht		0.386 kg / 1000 stuk
Douane tarief nummer		73 181 499