

Spec Sheet STP320250090B

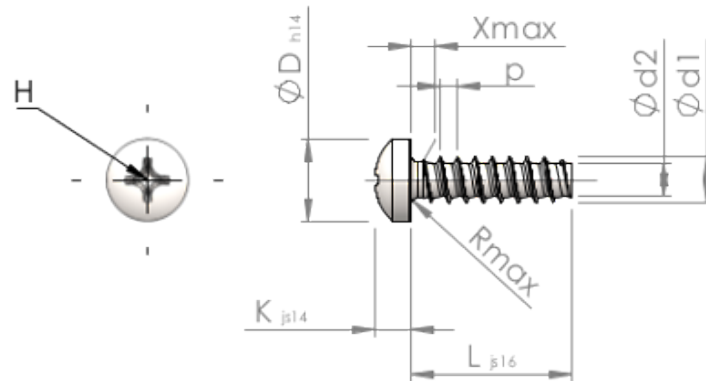

Item Number		STP320250090B
Standard		KN6032
Material		steel, hardened
Surface		Zinc-Nickel-plated min. 5µm, passivated black/ Cr-VI-free, baked, sealed
Thread Outside-Ø	d1	2.50 ^{+0.10} mm
Thread Core-Ø	d2	1.72 mm
Thread Pitch	p	0.95 mm
Length	L	9.00 ±0.45 mm
Head-Ø	D	4.40 _{-0.30} mm
Head Height	K	1.900 ±0.125 mm
Thread Run-Out	X	1.30 mm
Radius	R	0.40 mm
Size Cross Recess		H1
Penetration Depth	t	0.92 - 1.38 mm
Thread		STS-plus
Weight		0.362 kg / 1000 pieces
Customs Tariff No		73 181 499