

Spec Sheet STP320220140S

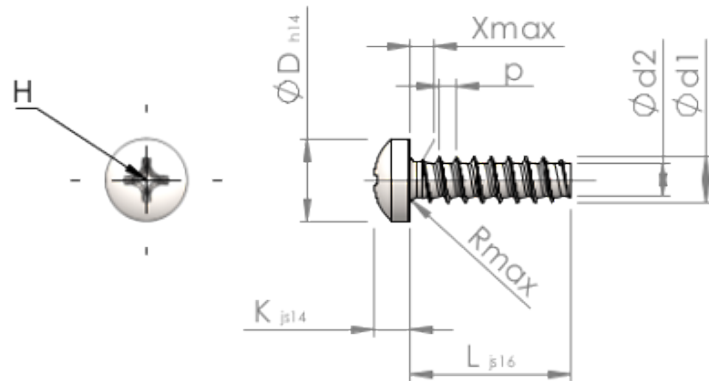

Item Number		STP320220140S
Standard		KN6032
Material		steel, hardened
Surface		zinc-plated 5-7 µm, baked, blue / transparent passivated
Thread Outside-Ø	d1	2.20 ^{+0.08} mm
Thread Core-Ø	d2	1.51 mm
Thread Pitch	p	0.85 mm
Length	L	14.00 ±0.55 mm
Head-Ø	D	3.90 _{-0.30} mm
Head Height	K	1.600 ±0.125 mm
Thread Run-Out	X	1.10 mm
Radius	R	0.35 mm
Size Cross Recess		H1
Penetration Depth	t	0.74 - 1.20 mm
Thread		STS-plus
Weight		0.357 kg / 1000 pieces
Customs Tariff No		73 181 499