

**Technische gegevens**  
**STP320220090B**

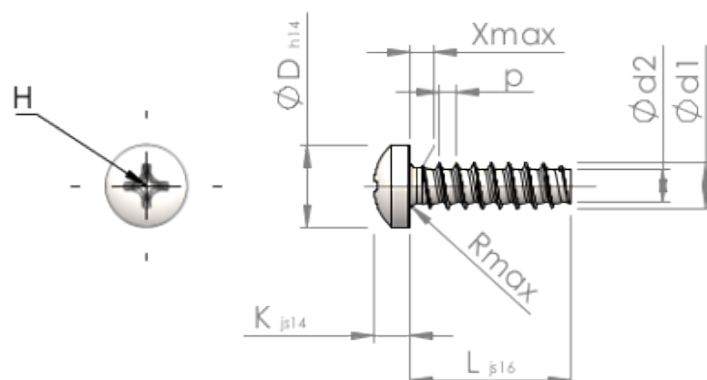

Produktnummer		STP320220090B
Norm		KN6032
Materiaal		veredeld staal
Oppervlak		ZnNi zwart-gepassiveerd, getempert, verzegeld
Schroefdraad buiten-Ø	<b>d1</b>	2.20 <sup>+0.08</sup> mm
Schroefdraad kern-Ø	<b>d2</b>	1.51 mm
Spoed	<b>p</b>	0.85 mm
Lengte	<b>L</b>	9.00 ±0.45 mm
Kop-Ø	<b>D</b>	3.90 <sub>-0.30</sub> mm
Kop hoogte	<b>K</b>	1.600 ±0.125 mm
Draaduitloop	<b>X</b>	1.10 mm
Radius	<b>R</b>	0.35 mm
Kruis Maat		H1
Indringdiepte	<b>t</b>	0.74 - 1.20 mm
Draad		STS-plus
Gewicht		0.264 kg / 1000 stuk
Douane tarief nummer		73 181 499