

Technische gegevens
STP320220070E

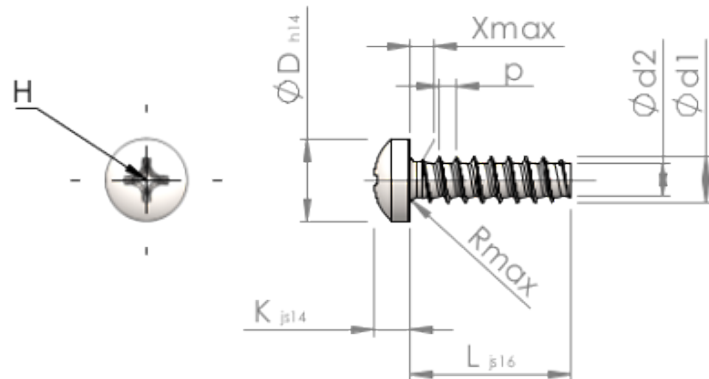

Produktnummer		STP320220070E
Norm		KN6032
Materiaal		roestvrij staal A2
Oppervlak		blank, geetst en gepassiveerd
Schroefdraad buiten-Ø	d1	2.20 ^{+0.08} mm
Schroefdraad kern-Ø	d2	1.51 mm
Spoed	p	0.85 mm
Lengte	L	7.00 ±0.45 mm
Kop-Ø	D	3.90 _{-0.30} mm
Kop hoogte	K	1.600 ±0.125 mm
Draaduitloop	X	1.10 mm
Radius	R	0.35 mm
Kruis Maat		H1
Indringdiepte	t	0.74 - 1.20 mm
Draad		STS-plus
Gewicht		0.227 kg / 1000 stuk
Douane tarief nummer		73 181 410