

Spec Sheet STP320220050S

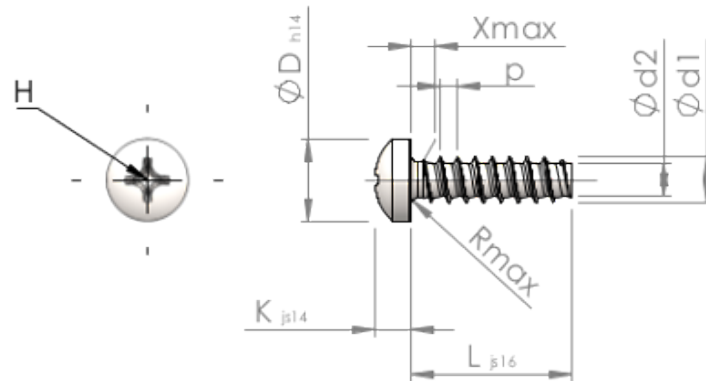

Item Number		STP320220050S
Standard		KN6032
Material		steel, hardened
Surface		zinc-plated 5-7 µm, baked, blue / transparent passivated
Thread Outside-Ø	<b>d1</b>	2.20 <sup>+0.08</sup> mm
Thread Core-Ø	<b>d2</b>	1.51 mm
Thread Pitch	<b>p</b>	0.85 mm
Length	<b>L</b>	5.00 ±0.38 mm
Head-Ø	<b>D</b>	3.90 <sub>-0.30</sub> mm
Head Height	<b>K</b>	1.600 ±0.125 mm
Thread Run-Out	<b>X</b>	1.10 mm
Radius	<b>R</b>	0.35 mm
Size Cross Recess		H1
Penetration Depth	<b>t</b>	0.74 - 1.20 mm
Thread		STS-plus
Weight		0.190 kg / 1000 pieces
Customs Tariff No		73 181 499