

# Spec Sheet STP310600400S

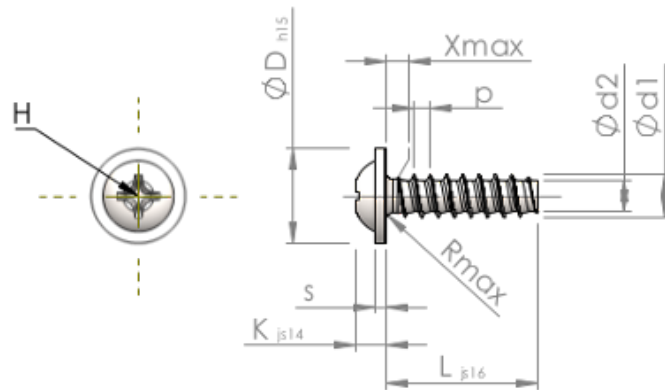

Item Number		STP310600400S
Standard		KN6031
Material		steel, hardened
Surface		zinc-plated 5-7 $\mu$ m, baked, blue / transparent passivated
Thread Outside- $\varnothing$	<b>d1</b>	6.00 $^{+0.15}$ mm
Thread Core- $\varnothing$	<b>d2</b>	4.26 mm
Thread Pitch	<b>p</b>	2.14 mm
Length	<b>L</b>	40.00 $\pm 0.80$ mm
Head- $\varnothing$	<b>D</b>	13.50 $_{-0.70}$ mm
Head Height	<b>K</b>	4.000 $\pm 0.150$ mm
Flange Thickness	<b>S</b>	1.40 mm
Thread Run-Out	<b>X</b>	3.00 mm
Radius	<b>R</b>	0.80 mm
Size Cross Recess		H3
Penetration Depth	<b>t</b>	2.24 - 2.90 mm
Thread		STS-plus
Weight		7.506 kg / 1000 pieces
Customs Tariff No		73 181 499