

Spec Sheet STP310600380S

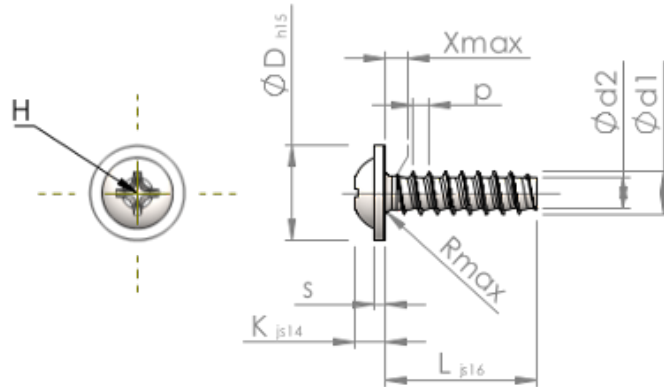

Item Number		STP310600380S
Standard		KN6031
Material		steel, hardened
Surface		zinc-plated 5-7 μ m, baked, blue / transparent passivated
Thread Outside- \varnothing	d1	6.00 $^{+0.15}$ mm
Thread Core- \varnothing	d2	4.26 mm
Thread Pitch	p	2.14 mm
Length	L	38.00 ± 0.80 mm
Head- \varnothing	D	13.50 $_{-0.70}$ mm
Head Height	K	4.000 ± 0.150 mm
Flange Thickness	S	1.40 mm
Thread Run-Out	X	3.00 mm
Radius	R	0.80 mm
Size Cross Recess		H3
Penetration Depth	t	2.24 - 2.90 mm
Thread		STS-plus
Weight		7.235 kg / 1000 pieces
Customs Tariff No		73 181 499