

Spec Sheet STP310600380E

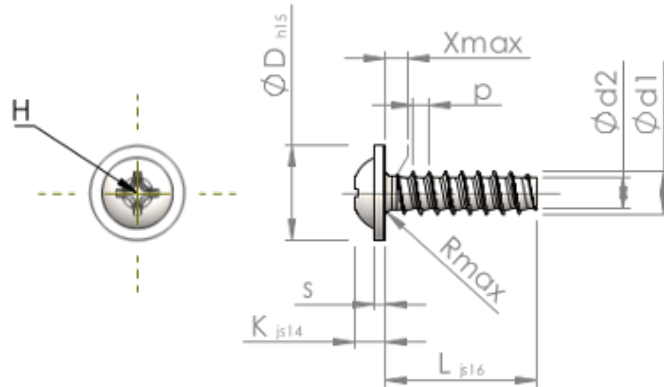

Item Number		STP310600380E
Standard		KN6031
Material		stainless-steel A2
Surface		bright, pickled and passivated
Thread Outside-Ø	d1	6.00 ^{+0.15} mm
Thread Core-Ø	d2	4.26 mm
Thread Pitch	p	2.14 mm
Length	L	38.00 ±0.80 mm
Head-Ø	D	13.50 _{-0.70} mm
Head Height	K	4.000 ±0.150 mm
Flange Thickness	S	1.40 mm
Thread Run-Out	X	3.00 mm
Radius	R	0.80 mm
Size Cross Recess		H3
Penetration Depth	t	2.24 - 2.90 mm
Thread		STS-plus
Weight		7.235 kg / 1000 pieces
Customs Tariff No		73 181 410