

**Technische gegevens**  
**STP310600350C**

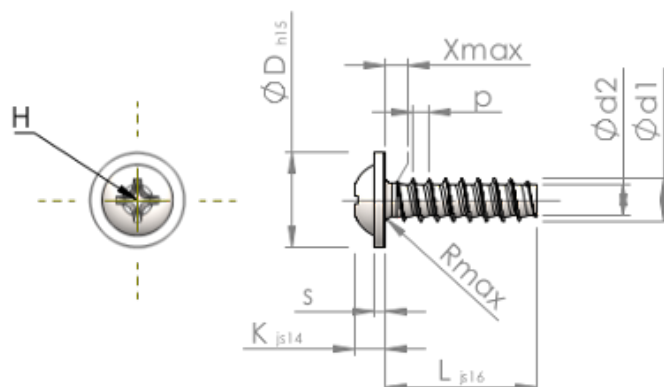

**SCREWERK**



Produktnummer		STP310600350C
Norm		KN6031
Materiaal		roestvrij staal A4
Oppervlak		blank, geetst en gepassiveerd
Schroefdraad buiten-Ø	<b>d1</b>	6.00 <sup>+0.15</sup> mm
Schroefdraad kern-Ø	<b>d2</b>	4.26 mm
Spoed	<b>p</b>	2.14 mm
Lengte	<b>L</b>	35.00 ±0.80 mm
Kop-Ø	<b>D</b>	13.50 <sub>-0.70</sub> mm
Kop hoogte	<b>K</b>	4.000 ±0.150 mm
Flensdikte	<b>S</b>	1.40 mm
Draaduitloop	<b>X</b>	3.00 mm
Radius	<b>R</b>	0.80 mm
Kruis Maat		H3
Indringdiepte	<b>t</b>	2.24 - 2.90 mm
Draad		STS-plus
Gewicht		6.828 kg / 1000 stuk
Douane tarief nummer		73 181 410