

Spec Sheet STP310600130S

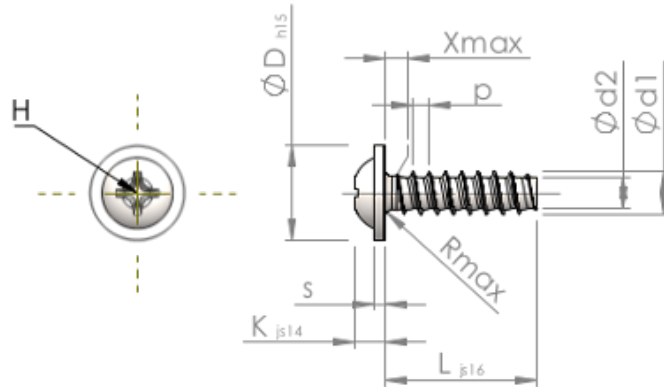

Item Number		STP310600130S
Standard		KN6031
Material		steel, hardened
Surface		zinc-plated 5-7 μm , baked, blue / transparent passivated
Thread Outside-Ø	d1	6.00 $^{+0.15}$ mm
Thread Core-Ø	d2	4.26 mm
Thread Pitch	p	2.14 mm
Length	L	13.00 ± 0.55 mm
Head-Ø	D	13.50 $_{-0.70}$ mm
Head Height	K	4.000 ± 0.150 mm
Flange Thickness	S	1.40 mm
Thread Run-Out	X	3.00 mm
Radius	R	0.80 mm
Size Cross Recess		H3
Penetration Depth	t	2.24 - 2.90 mm
Thread		STS-plus
Weight		3.844 kg / 1000 pieces
Customs Tariff No		73 181 499