

**Technische gegevens**  
**STP310500650B**

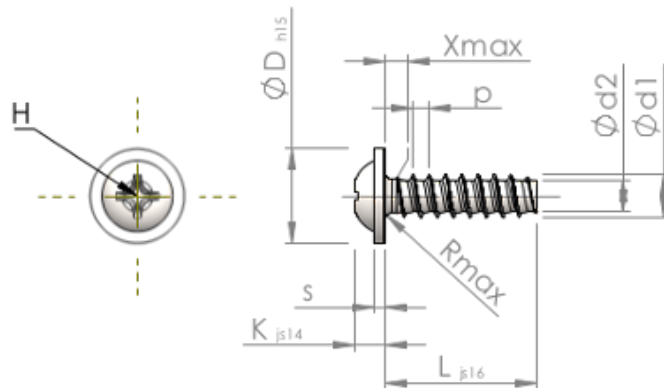

Produktnummer		STP310500650B
Norm		KN6031
Materiaal		veredeld staal
Oppervlak		ZnNi zwart-gepassiveerd, getempert, verzegeld
Schroefdraad buiten-Ø	<b>d1</b>	5.00 <sup>+0.15</sup> mm
Schroefdraad kern-Ø	<b>d2</b>	3.53 mm
Spoed	<b>p</b>	1.80 mm
Lengte	<b>L</b>	65.00 ±0.95 mm
Kop-Ø	<b>D</b>	11.00 <sub>-0.70</sub> mm
Kop hoogte	<b>K</b>	3.200 ±0.150 mm
Flensdikte	<b>S</b>	1.20 mm
Draaduitloop	<b>X</b>	2.50 mm
Radius	<b>R</b>	0.70 mm
Kruis Maat		H2
Indringdiepte	<b>t</b>	1.98 - 2.61 mm
Draad		STS-plus
Gewicht		7.371 kg / 1000 stuk
Douane tarief nummer		73 181 499