

Spec Sheet STP310500380E

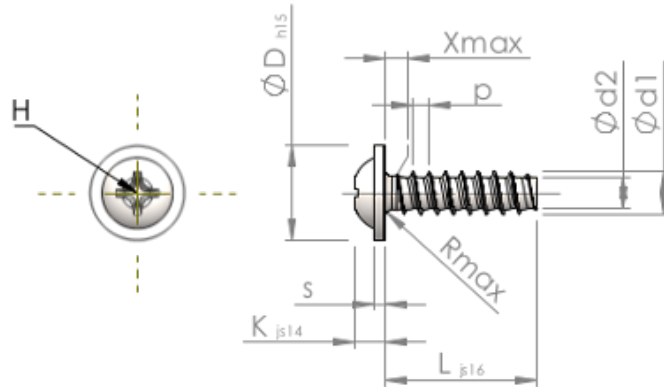

Item Number		STP310500380E
Standard		KN6031
Material		stainless-steel A2
Surface		bright, pickled and passivated
Thread Outside-Ø	<b>d1</b>	5.00 <sup>+0.15</sup> mm
Thread Core-Ø	<b>d2</b>	3.53 mm
Thread Pitch	<b>p</b>	1.80 mm
Length	<b>L</b>	38.00 ±0.80 mm
Head-Ø	<b>D</b>	11.00 <sub>-0.70</sub> mm
Head Height	<b>K</b>	3.200 ±0.150 mm
Flange Thickness	<b>S</b>	1.20 mm
Thread Run-Out	<b>X</b>	2.50 mm
Radius	<b>R</b>	0.70 mm
Size Cross Recess		H2
Penetration Depth	<b>t</b>	1.98 - 2.61 mm
Thread		STS-plus
Weight		4.846 kg / 1000 pieces
Customs Tariff No		73 181 410